

revolution of cutting



CUTTING TOOLS

- Cutter Wheels
- Patch Planers
- Rotary Drum Cutters
- Chain Cutters

KEMROC[®]

ROUND ATTACK PICKS, PICK BOXES, RETAINING CLIPS

For **KEMROC** cutters and cutter wheels

KEMROC cutters and cutting wheels work under extremely hard conditions in trenching, demolition, rock excavation and tunnelling, in steel mills as in other unusual applications. This puts very high demands on the cutter drums and cutting tools.

The result of many years experience, with machines working around the world, can be seen in the type of picks used and their cutting pattern on equipment. This unique combination provides maximum productivity with minimum wear, ensuring the economical performance of **KEMROC** products even in the hardest conditions. Modern technology and continuous product development are the basics for ensuring the economic benefits of using our cutting tools and attachments.

In our range of cutter picks, we have paid special attention to the optimum shape, high quality materials and sustainable quality of the production process. This helps you to keep your consumable costs to a minimum.



Additional head designs are in main product catalogue.

This catalogue should provide an overview of our standard range of cutter tools, pick boxes and retainer clips, suitable for a wide range of applications.

In addition to alternative design cutter drums, we also offer a large variety of pick types even for unusual applications.







If you have an extremely unusual application or requirement, don't hesitate to contact us. Our specialists are pleased to provide advice and support in your search for the most suitable cutter tools.



An **ETR RANGE** working



An **ETR RANGE** working

	KEMROC Product catalog Page	KEMROC Tool catalog Page
Several picks "Piece by piece"	–	4 – 5
Cutting tools for	–	
Symbol	Model	Cutter type
	EX 20 20 HD EX 30 HD EX 45 HD EX 60 HD	Surface Planers (Exactor)
		16 – 17
		16 – 17
		16 – 17
		16 – 17
	ES 20 20 HD ES 30 HD ES 45 HD ES 60 HD	Universal Cutters (Flexator)
		18 – 19
		18 – 19
		18 – 19
		18 – 19
	SMW 50 SMW 80 SMW 110	Trencher for slot cutting
		20 – 21
		20 – 21
		20 – 21
	DMW 90 DMW 130 DMW 220 DMW 220 HD	Cutter Wheels (Erwetor)
		22 – 23
		22 – 23
		22 – 23
		22 – 23
	ETR 1 ETR 3	Chain Trencher
		24 – 25
		24 – 25
	EK 100 EK 140	Chain Cutters (Erkator)
		26 – 27
		26 – 27
Non-standard and special picks	–	14
Tools for installation and removal	–	15

SEVERAL PICKS – "PIECE BY PIECE"



THE OPTIMUM SHAPE

The type of roand attack picks and their pattern on the cutter drum determines how effectively rock is cut which requires specialist knowledge and expertise in geology and cutting technology.

It is the pick that breaks portions of rock out during the cutting operation. Due to the range of rock types, their hardness and toughness, a variety of drum design are required to achieve optimum penetration in each type of rock.

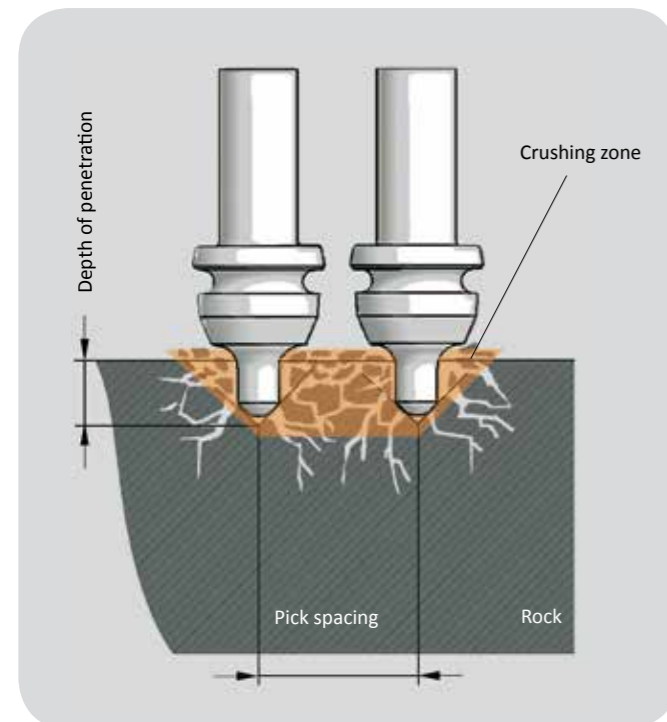
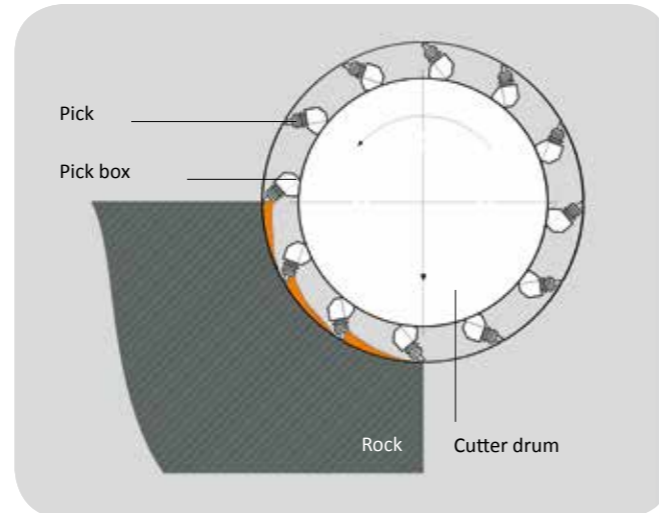

For each model of drum cutter, **KEMROC** offers a range of pick types allowing the best possible solution for each application. For example:

- ER 15/90/70/30 (1)**
Narrow pick head with small diameter insert, for use in soft rock
- ER 17/75/70/30 (2)**
Standard pick head with medium diameter insert, for use in soft to medium hard rock
- ER 22/75/70/30 (3)**
Standard pick head with medium diameter insert, for use in medium to hard rock, reinforced concrete
- ER 25/77/70/30 (4)**
Standard pick head with large diameter insert, for use in very hard rock
- ER 30/77/70/30 (5)**
Standard pick head with large insert cap, for use in soft to medium hard but abrasive rock



ROAND ATTACK PICKS

The tungsten carbide insert braised into the body of the pick is at the heart of the cutting operation and is subject to extreme stresses due to it coming continuously into contact with the rock.

The pick body, (head and shaft) is made from heattreated steel and serves as the support for the tungsten carbide insert and also as protection for the pick box. The tungsten carbide insert is extremely wear resistant and tough to withstand impact.

The insert is a sintered material made up of tungsten carbide with a cobalt binder. Depending on application, a variety of carbide grades and shapes are available.

PICK BOXES

Pick boxes welded onto the cutter head or cutter wheel determine where and how picks penetrate into the rock. The special attack angle ensures a continuous rotation of the pick creating a self sharpening action for the tungsten carbide insert during the cutting action. The correct angle ensures maximum productivity with minimum wear. Pick boxes are also made from specially heat treated steel and depending on applications, are available with exchangeable wear sleeves.

RETAINING CLIPS

Retaining clips ensure that picks do not fly out of the pick boxes. Various types of retaining clip are available depending on pick type and application area e.g. retaining collars for soft rock or circlip type systems for hard rock applications.

For quick and easy changing of picks, **KEMROC** offers the **QuickSnap** retaining system, which allows picks to be changed in a matter of seconds. This represents a saving of over 50 % in time compared with normal circlip or knock on retainer systems.

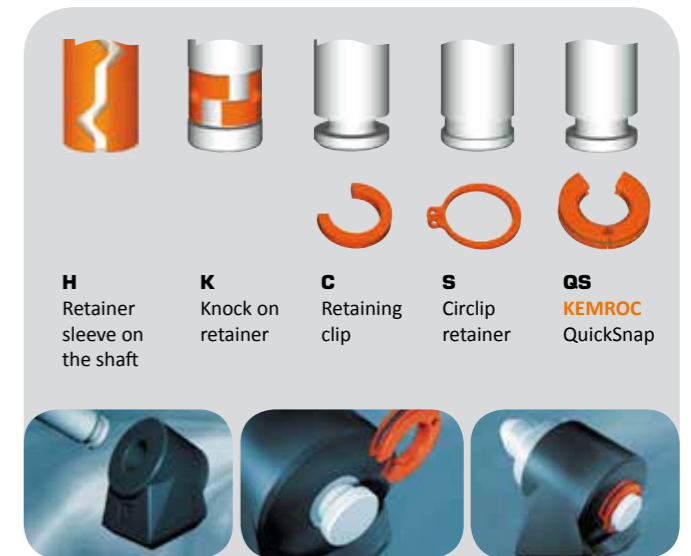
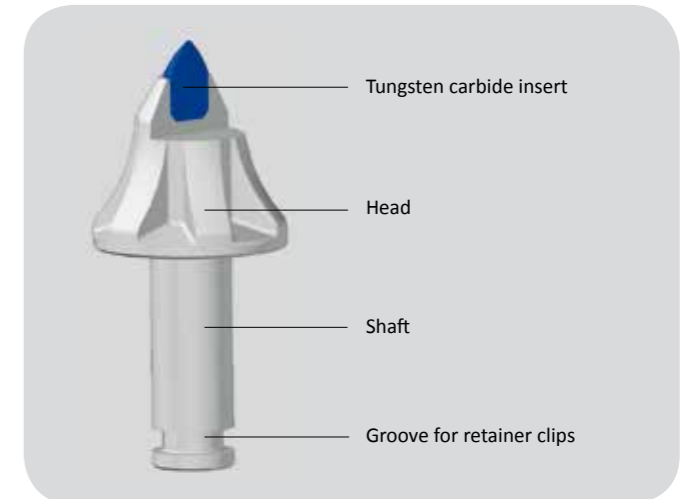

Easier and quicker pick changes with **KEMROC** QuickSnap

EX 20 | 20 HD
ES 20 | 20 HD Cutter drum



Pick box	PH 80
Part Number	71 12 22

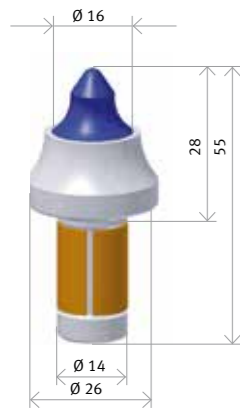

Pick type	ER 16/28/26/14 H
Part Number	16 28 26 14
Application	Asphalt, concrete, soft to medium hard rock



Dimension in mm | Associated installation and removal tools on page 15
 ● Delivery ex stock | ● Delivery upon request

EX 30 HD | 45 HD | 60 HD
ES 30 HD | 45 HD | 60 HD Cutter drum



Pick box	PH 250
Part Number	72 10 24

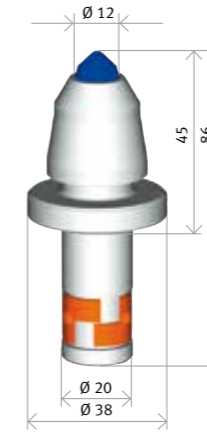

Pick type	ER 12/45/38/20 K
Part Number	12 45 38 20
Application	Concrete, soft to medium hard rock

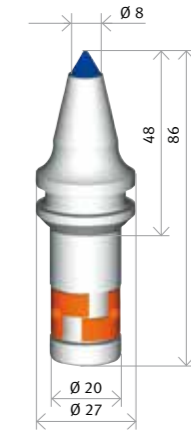

Pick type	ER 09/51/25/20 K
Part Number	9 51 25 20
Application	Soft rock, salt, gypsum

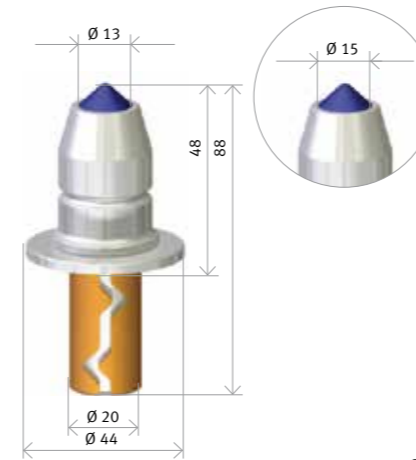

Pick type	ER 13/48/44/20 H
Part Number	13 48 44 20

Pick type	ER 15/48/44/20 H
Part Number	15 48 44 20
Application	Concrete, soft to medium hard rock



Pick type	ER 16/46/38/20 C
Part Number	16 46 38 20
Application	Concrete, soft to medium hard rock



Retainer	Retaining clip
Part Number	ES 250 99 99 99 91

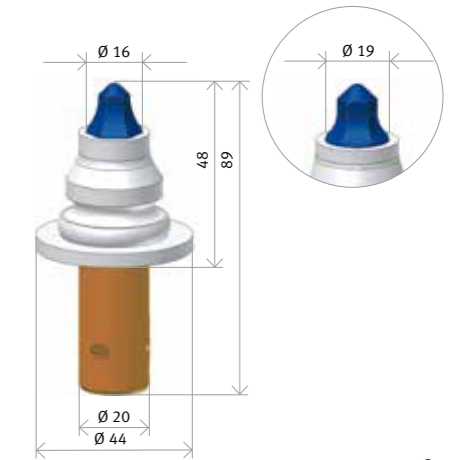

Pick type	ER 16/48/32/20 H
Part Number	16 48 32 20

Pick type	ER 19/48/36/20 H
Part Number	19 48 36 20
Application	Asphalt

Dimension in mm | Associated installation and removal tools on page 15
 ● Delivery ex stock | ● Delivery upon request

DMW 90 SMW 50 | 80 | 110



Pick box	PH 600 UA
Part Number	76 10 25 UA



Pick type	ER 22/64/60/25 H
Part Number	22 64 60 25
Application	Asphalt, soft and abrasive rock

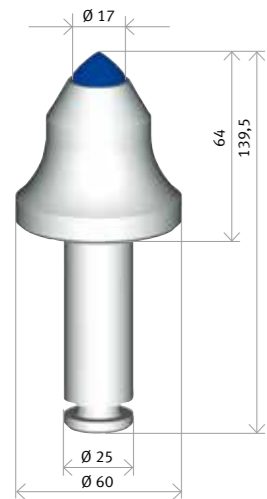

Pick type	ER 17/64/60/25 C
Part Number	17 64 60 25
Application	Concrete, medium hard to hard rock



Retainer	Retaining clip ES 600
Part Number	99 99 99 94

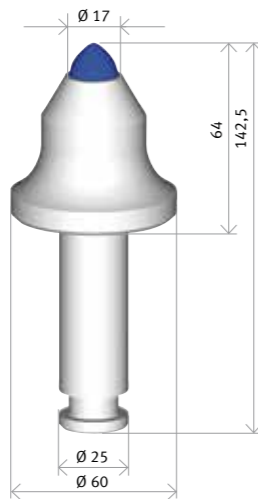

Pick type	ER 17/64/60/25 Q
Part Number	17 64 60 26
Application	Concrete, medium hard to hard rock



Retainer	QuickSnap QS 600
Part Number	99 25 00 25

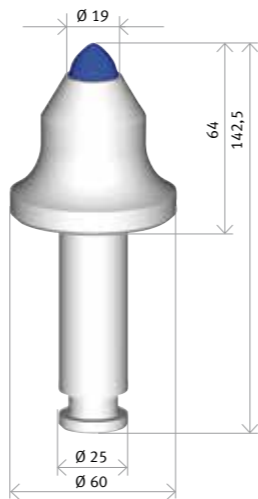

Pick type	ER 19/64/60/25 Q
Part Number	19 64 60 26
Application	Concrete, medium hard to hard rock



Retainer	QuickSnap QS 600
Part Number	99 25 00 25

ETR 1



Pick box	PH 450 UA
Part Number	72 10 25 UA
Application	replaces the previous type PH 450 (part number 72 10 25)



Pick type	ER 19/51/45/22 H
Part Number	19 51 45 22
Application	Asphalt, soft and abrasive rock

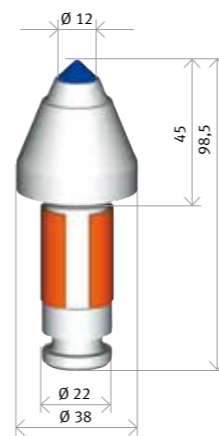

Pick type	ER 12/45/38/22 HC
Part Number	12 45 38 23
Application	Concrete, medium hard and abrasive rock



Retainer	Retaining clip ES 450
Part Number	99 99 99 96



Pick type	ER 15/46/38/22 C
Part Number	15 46 38 22
Application	Concrete, medium hard rock



Retainer	Retaining clip ES 450
Part Number	99 99 99 96

ETR 3



Pick box	PH 1000
Part Number	71 16 10
For drum cutter model	ER 650 ERL 1100



Pick type	ER 30/77/70/29 Q
Part Number	30 77 70 32
Application	Soft to medium hard, abrasive rock



Retainer	QuickSnap QS 5000
Part Number	99 50 00 30

Dimension in mm | Associated installation and removal tools on page 15
● Delivery ex stock | ● Delivery upon request

Order Hotline +49 3695 85025-50 | www.kemroc.de | sales@kemroc.de

Dimension in mm | Associated installation and removal tools on page 15
● Delivery ex stock | ● Delivery upon request

SMW 110 DMW 90 | 130 | 220 | 220 HD EK 100 | 140



Pick box	PH 1200
Part Number	71 10 26
For drum cutter model	ER 1200

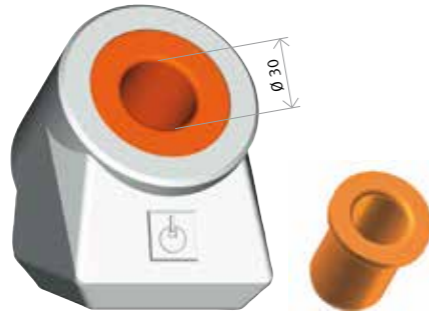

Pick box	PH 1500
Part Number	71 10 22
For drum cutter model	ERW 400, ERW 600, ERW 1000, ERW 1200
	Replacement wear sleeve
Part Number	71 10 29

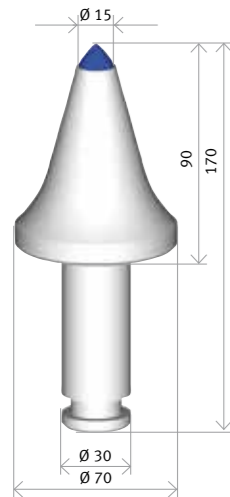

Pick type	ER 15/90/70/30 G
Part Number	15 90 70 35
Application	Salt, gypsum, medium hard, fractured rock



Retainer	QuickSnap QS 5000
Part Number	99 50 00 30

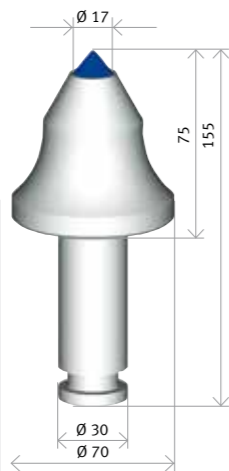

Pick type	ER 17/75/70/30 G
Part Number	17 75 70 35
Application	Concrete, medium hard rock



Retainer	QuickSnap QS 5000
Part Number	99 50 00 30



Pick type	ER 19/75/70/30 G
Part Number	19 75 70 35 E
Application	Concrete, medium hard rock



Retainer	QuickSnap QS 5000
Part Number	99 50 00 30



Pick type	ER 17/75/70/30 S
Part Number	17 75 70 30 E
Application	Medium hard rock



Retainer	Circlip retainer SG 1500
Part Number	99 99 99 99

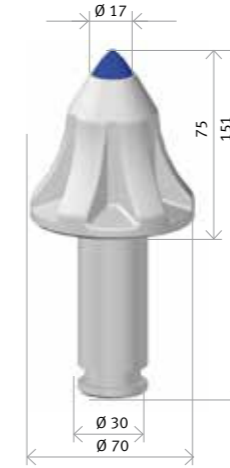

Pick type	ER 17/75/70/30 C
Part Number	17 75 70 30 S
Application	Medium hard rock



Retainer	Retaining clip ES 1500
Part Number	99 99 99 98



Pick type	ER 22/75/70/30 G
Part Number	22 75 70 30
Application	Concrete, medium hard to hard rock



Retainer	QuickSnap QS 5000
Part Number	99 50 00 30



Pick type	ER 25/77/70/30 G
Part Number	25 75 70 35
Application	Steel, concrete, hard to very hard rock



Retainer	QuickSnap QS 5000
Part Number	99 50 00 30



Dimension in mm | Associated installation and removal tools on page 15
● Delivery ex stock | ● Delivery upon request

Dimension in mm | Associated installation and removal tools on page 15
● Delivery ex stock | ● Delivery upon request

PICKS FOR CUTTING WHEELS



ES RANGE WOOD WHEELS

ES 20 | 20 HD | 30 HD | 45 HD | 60 HD
Till 12 – 2015



Pick box	for ES drag picks
Part Number	79 10 35

ES RANGE SLOTTING WHEELS

ES 20 | 20 HD | 30 HD



Pick box	PH 70
Part Number	71 10 32

ES RANGE SMW RANGE SLOTTING WHEELS

ES 45 HD | 60 HD
SMW 90 | 130



Pick box	PH 100 N
Part Number	79 10 04 E

ES RANGE STRAIGHT TOOTH FOR WOOD WHEELS

ES 20 | 20 HD | 30 HD | 45 HD | 60 HD
From 04 – 2016



Pick type	Straight tooth (left) with thread connection
Part Number	57 13 72
Application	Wood, tree stumps



Pick type	Straight tooth with thread connection
Part Number	57 13 70
Application	Wood, tree stumps

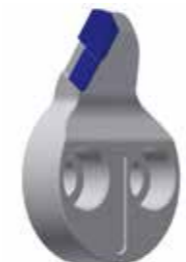

Pick type	Straight tooth (right) with hole
Part Number	57 13 71
Application	Wood, tree stumps



Pick type	Straight tooth with hole
Part Number	57 13 73
Application	Wood, tree stumps

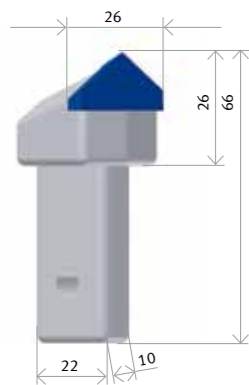

Pick type	ES DRAG PICKS
Part Number	79 10 34
Application	Wood, tree stump



Pick type	ER 16/29/25/14 C
Part Number	16 29 25 14
Application	Asphalt, concrete, soft to medium hard rock



Pick type	ER 19/33/30/15 S
Part Number	19 33 30 15
Application	Asphalt, concrete, soft to medium hard rock



Retaining pin	ES 06
Part Number	70 50 69



Retainer	Retaining clip ES 70
Part Number	99 99 99 76



Retainer	Circlip retainer SG 100
Part Number	99 99 99 90

Dimension in mm | Associated installation and removal tools on page 15
● Delivery ex stock | ● Delivery upon request

Dimension in mm | Associated installation and removal tools on page 15
● Delivery ex stock | ● Delivery upon request

SPECIAL AND NON-STANDARD PICKS



MOUNTING AND DISMANTLING TOOLS



DRAGON-TOOTH-PICKS



Pick box	PH 450 UA
Part Number	72 10 25 UA



Pick box	PH 600 UA
Part Number	76 10 25 UA



Pick box	PH 5300 DT
Part Number	71 16 11 UA

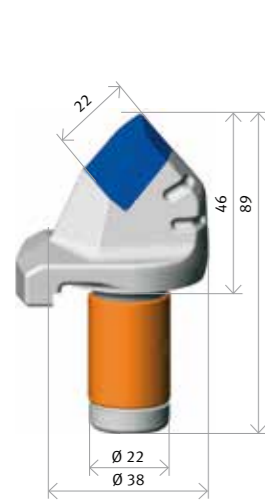

Pick type	DT 22/46/38/22
Part Number	22 38 46 22
Application	Soft to medium hard, abrasive ground and rock

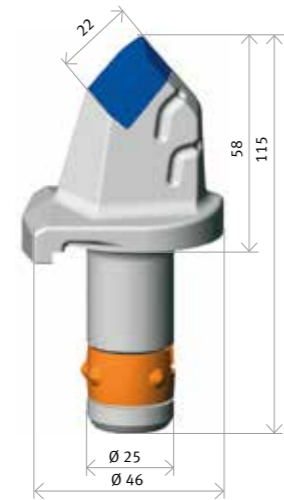

Pick type	DT 22/58/46/25
Part Number	22 46 58 25
Application	Soft to medium hard, abrasive ground and rock

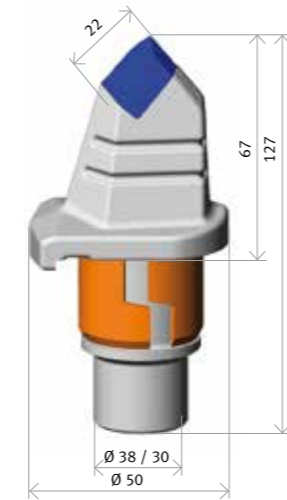

Pick type	DT 22/67/50/38-30
Part Number	22 67 50 38
Application	Soft to medium hard, abrasive ground and rock



Tool	KNOCK-OUT TOOL	
Part Number	for picks with shaft diameter 20-30 mm	
	99 99 99 95	



Tool	PULLER FOR PICKS WITH RETAINING SLEEVES	
Part Number	for picks with shaft diameter 20-22 mm	
	for pick ER 16/48/32/20 HC (S. 7)	
	99 99 99 97	99 99 99 13



Tool	MOUNTING TOOL FOR RETAINING CLIPS	DISMANTLING TOOL FOR RETAINING CLIPS
Part Number	for retaining clip ES 250	99 99 99 42
	for retaining clip ES 450	99 99 99 47
	for retaining clip ES 600	99 99 99 83
	for retaining clip ES 1500	99 99 99 39
		99 99 99 43
		99 99 99 48
		99 99 99 82
		99 99 99 36



Tool	MOUNTING GRIPPER FOR CIRCLIP RETAINERS	
Part Number	for picks with shaft diameter till 25 mm	
	for picks with shaft diameter from 30 mm	
	99 99 99 40	99 99 99 46



Tool	PULLER TOOL FOR QUICKSNAP RETAINERS	
Part Number	99 99 50 00	



Tool	KNOCK OUT TOOL FOR STUCK PICKS	
Part Number	for picks with shaft diameter 20-25 mm	
	for picks with shaft diameter 30-38 mm	
	99 99 99 38	99 99 99 37

Dimension in mm | Associated installation and removal tools on page 15

● Delivery ex stock | ● Delivery upon request

Order Hotline +49 3695 85025-50 | www.kemroc.de | sales@kemroc.de

SALES WORLDWIDE

revolution of cutting



KEMROC has a network of experienced business partners, own subsidiaries and distributors.
For more information please contact www.kemroc.de

Your local dealer

This catalogue is used to describe our products and the accessories. The information contained in it does not imply any certified properties or indicate any suitability for certain or assumed purposes. Technical changes are reserved without prior announcement. We disclaim any liability arising from the illustrations and information in the catalogue and from all our representatives.

KEMROC Spezialmaschinen GmbH
Jeremiasstrasse 4
D-36433 Leimbach
Germany

KEMROC Spezialmaschinen GmbH
Production and Service
Ahornstraße 6
D-36469 Hämbach
Germany

Phone +49 3695 85025-50
Fax +49 3695 85025-79
info@kemroc.de
www.kemroc.de